



SURGICAL
TECHNIQUE

enovis™

DYNACLIP FORTE®

BONE FIXATION THAT EMPOWERS ACTIVE, ADAPTIVE HEALING

STAPLE SYSTEM





**NEXT GENERATION
STRENGTH THAT CLIPS
THE COMPETITION**

FEATURES	3
TECHNICAL SPECIFICATIONS	5
ACCESSORY INSTRUMENTATION	6
INDICATIONS & CONTRAINDICATIONS	9
PROCEDURAL SIZING CHART	10
SURGICAL TECHNIQUE	11
REMOVAL & RE-INSERTION	20
ORDERING INFORMATION	21

Enovis™ is a manufacturer of orthopedic implants and does not practice medicine. This surgical technique was prepared in conjunction with licensed health care professionals. The treating surgeon is responsible for determining the appropriate treatment, technique(s), and product(s) for each individual patient.

See package insert for complete list of potential adverse effects, contraindications, warnings and precautions.

A workshop training is recommended prior to performing your first surgery. All non-sterile devices must be cleaned and sterilized before use.

Multi-component instruments must be disassembled for cleaning. Please refer to the corresponding assembly/disassembly instructions, if applicable. Please remember that the compatibility of different product systems has not been tested unless specified otherwise in the product labeling.

The surgeon must discuss all relevant risks including the finite lifetime of the device with the patient.

The latest innovation in NiTiNOL, DynaClip Forte® is a robust staple system that meets all surgeon demands for challenging, high load-bearing applications requiring greater compression and stability than traditional 2-leg designs.

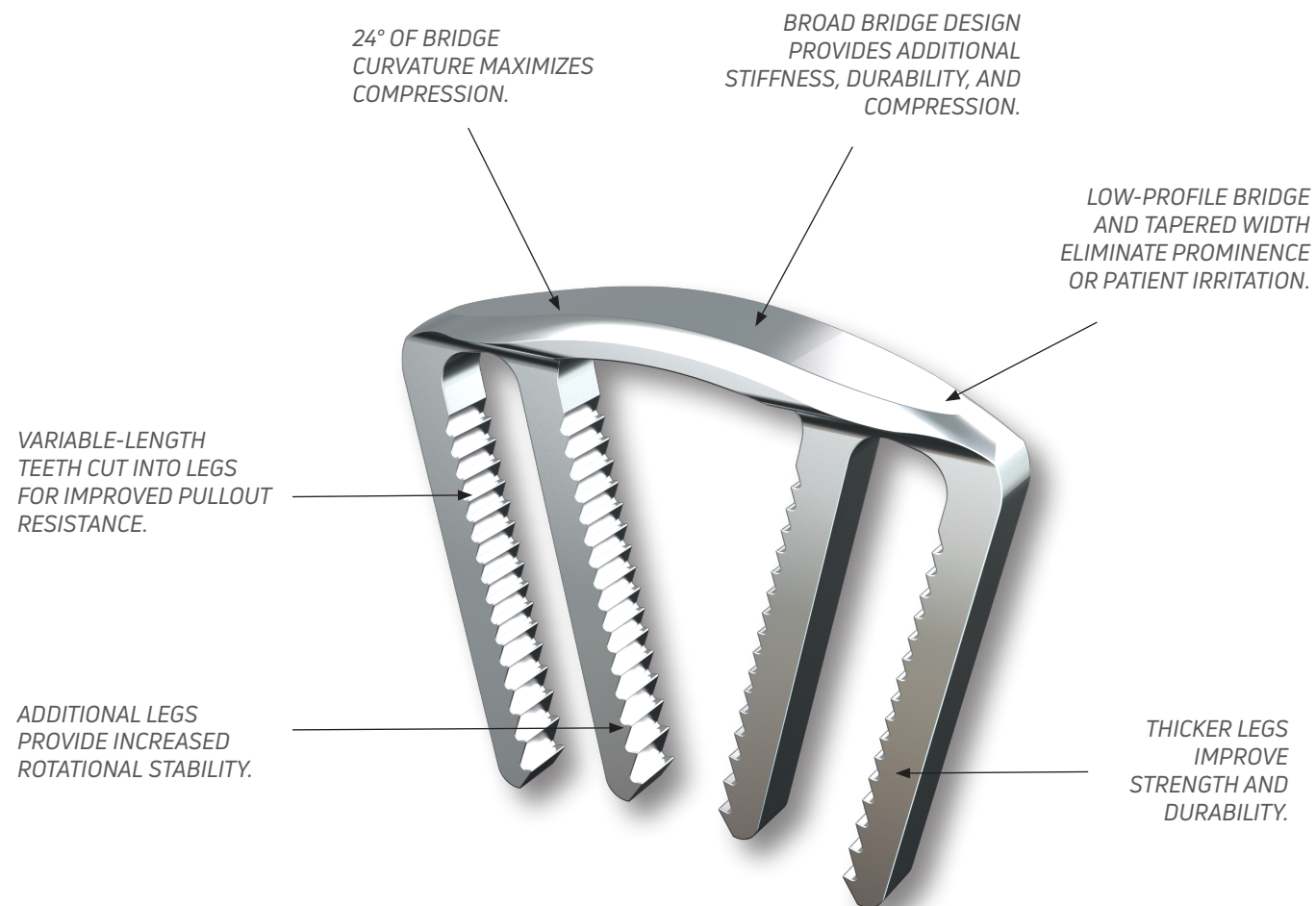

DYNACLIP FORTE® INSERTER

The DynaClip Forte® comes pre-loaded on a disposable Inserter that allows for fast and easy deployment.

- 1. Inserter Tip:** Retains the DynaClip Forte on the Inserter with the bottom also serving as a tamp to impact the staple flush with the bone.
- 2. Sliding Neck:** Pull up on the Sliding Neck to expose the DynaClip Forte on the Inserter Tip and release from the Inserter.
- 3. Blue Arrow:** Indicates the direction the Inserter slides away during deployment.
- 4. Strike Surface:** Mallet the Strike Surface when tamping to fully seat the DynaClip Forte.



LEGEND

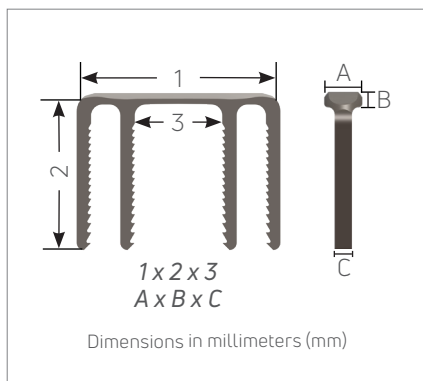

26 x 16 x 12
5.5 x 1.5 x 2.5



30 x 16 x 16
5.5 x 1.5 x 2.5



26 x 20 x 12
5.5 x 1.5 x 2.5



30 x 20 x 16
5.5 x 1.5 x 2.5

UNIVERSAL PROCEDURE PACK

Disposable, single-use sterile kit contains all instruments required to implant the DynaClip Forte®. No need to open multiple packs!

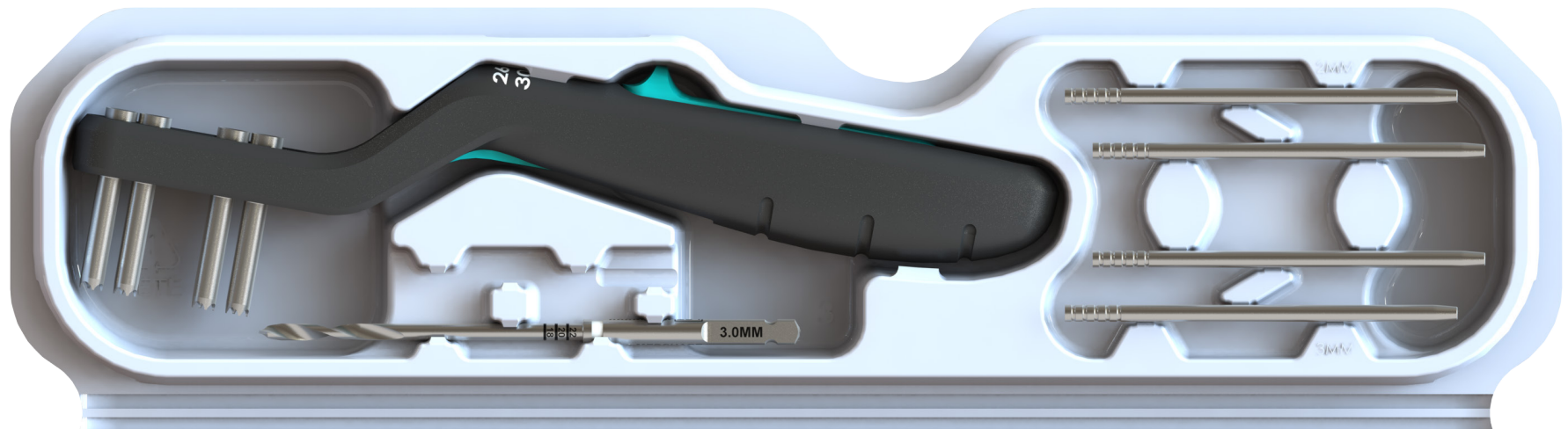

DRILLS & PINS

- 1. 3.0 mm Drill:** Laser Markings may be used to measure Drill depth.
- 2. 3.0 mm Locator Pin:** Fixate the Universal Drill Guide in place during drilling to ensure accurate distance between drill holes and for visualization under fluoroscopy.



3.0 MM DRILL



3.0 MM PIN

INDICATIONS

DYNACLIP FORTE® BONE FIXATION SYSTEM

The DynaClip Forte® Bone Fixation System is indicated for:

- Fracture, osteotomy fixation, and joint arthrodesis of the hand and foot.
- Fixation of proximal tibial metaphysis osteotomy.
- Fixation of small fragments of bone (i.e. small fragments of bone which are not comminuted to the extent to preclude staple placement). These fragments may be located in long bones such as the femur, fibula, and tibia in the lower extremities; the humerus, ulna, or radius in the upper extremities; the clavicle; and in flat bone such as the pelvis and scapula.

CONTRAINDICATIONS

DYNACLIP FORTE BONE FIXATION SYSTEM

The DynaClip Forte Bone Fixation System is contraindicated for:

- Infection.
- Patient conditions including blood supply limitations, obesity, and insufficient quantity or quality of bone.
- Patients with mental or neurologic conditions who are unwilling or incapable of following postoperative care instructions.
- Foreign body sensitivity. Where material sensitivity is suspected, testing is to be completed prior to implantation of device.

The diagram and chart highlight some of the suggested indications and recommended sizing for the DynaClip Forte® implants by procedure.

INDICATION		NO. OF STAPLES	BRIDGE LENGTH x LEG LENGTH
1	MTPJ FUSION	1	26 x 20, 30 x 20, 26 x 16, 30 x 16
2	LAPIDUS FUSION	1	26 x 20, 30 x 20, 26 x 16, 30 x 16
3	NAVICULOCUNEIFORM FUSION	1	26 x 20, 30 x 20
4	TALONAVICULAR FUSION	1-2	26 x 20, 30 x 20
5	2ND/3RD TMT FUSION	1	26 x 20, 30 x 20, 26 x 16, 30 x 16
6	CALCANEOCUBOID FUSION	1	26 x 20, 30 x 20

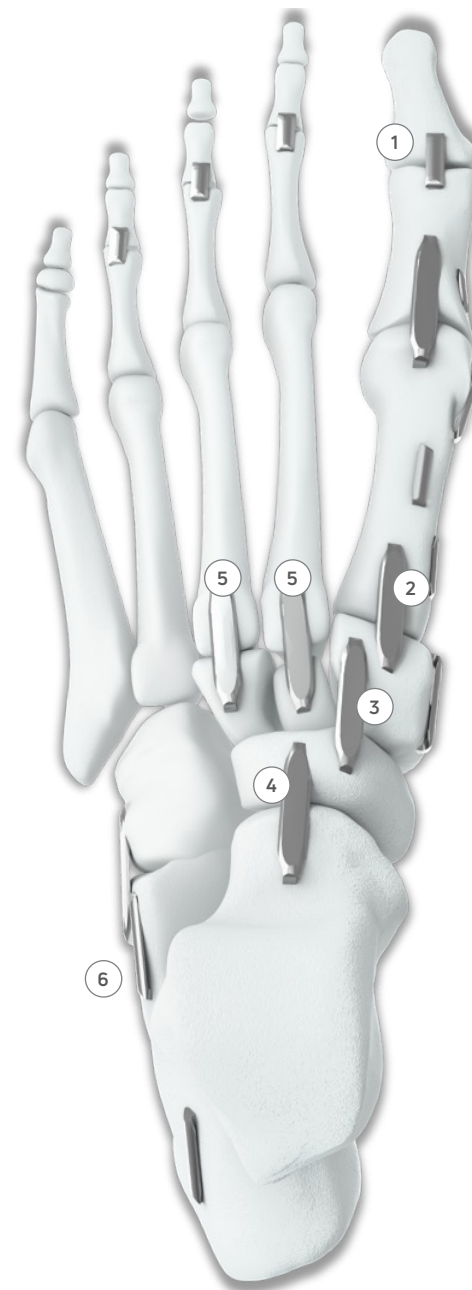

1. PREPARE THE FUSION SITE

Create the osteotomy and/or prepare the fusion site needed to implant the DynaClip Forte®.

2. SIZE AND PREPARE FOR DRILLING

Determine the appropriate DynaClip Forte bridge length by placing the Universal Drill Guide Sleeves perpendicular across the osteotomy or fusion site (**FIGURE 1**). Adjust the distance between the Guide Sleeves by moving the Drill Guide Slide to the necessary width (**A**).

The bridge length of the DynaClip Forte corresponds to the sizing indicated by the white numbering on the Drill Guide Body (red arrow). If desired, the placement of the Guide Sleeves on the bone surface can be confirmed under fluoroscopy.



FIGURE 1

3. DRILL THE FIRST HOLE

Using the 3.0 mm Drill, drill a pilot hole through Drill Guide Sleeve #1 (FIGURE 2). Use the laser markings on the Drill to measure drill depth. It is recommended to drill to the same depth as the staple leg length.

Before drilling the second hole, place a 3 mm Locator Pin in the first hole through Drill Guide Sleeve #1 to stabilize the positioning of the Universal Drill Guide (FIGURE 3).

TIP:

- Ensure the Size Indicator remains in the desired position during drilling.
- The Locator Pins may be lightly malleted to ensure they are fully seated into the drilled holes.

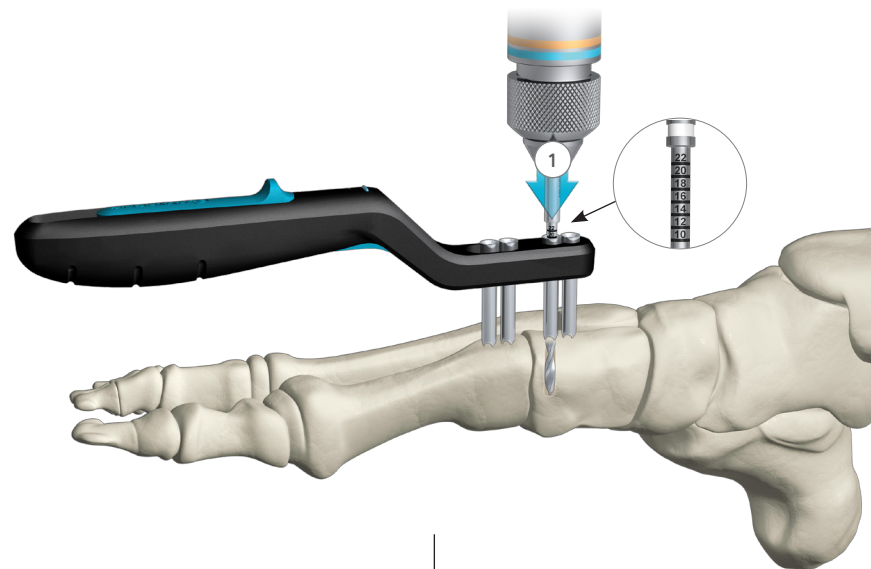

FIGURE 2

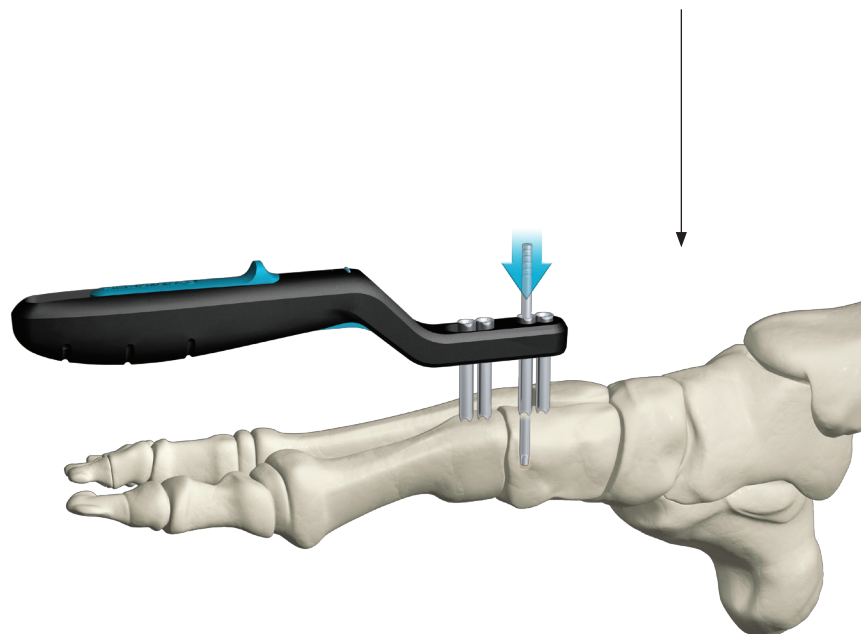

FIGURE 3

4. DRILL EACH ADDITIONAL HOLE

Repeat Step 3 for Drill Guide Sleeves #2, 3, and 4 (FIGURE 4, in order indicated), taking care to place a Locator Pin in each drilled hole before drilling through the next Drill Guide Sleeve.

OPTIONAL: Place a fourth Locator Pin in Drill Guide Sleeve #4. Remove the Universal Drill Guide but keep the Locator Pins in place to visualize the positioning under fluoroscopy. When satisfied with placement, remove Locator Pins from the pilot holes.

TIP:

- Apply compression across the fusion site before drilling through Drill Guide Sleeve #2.

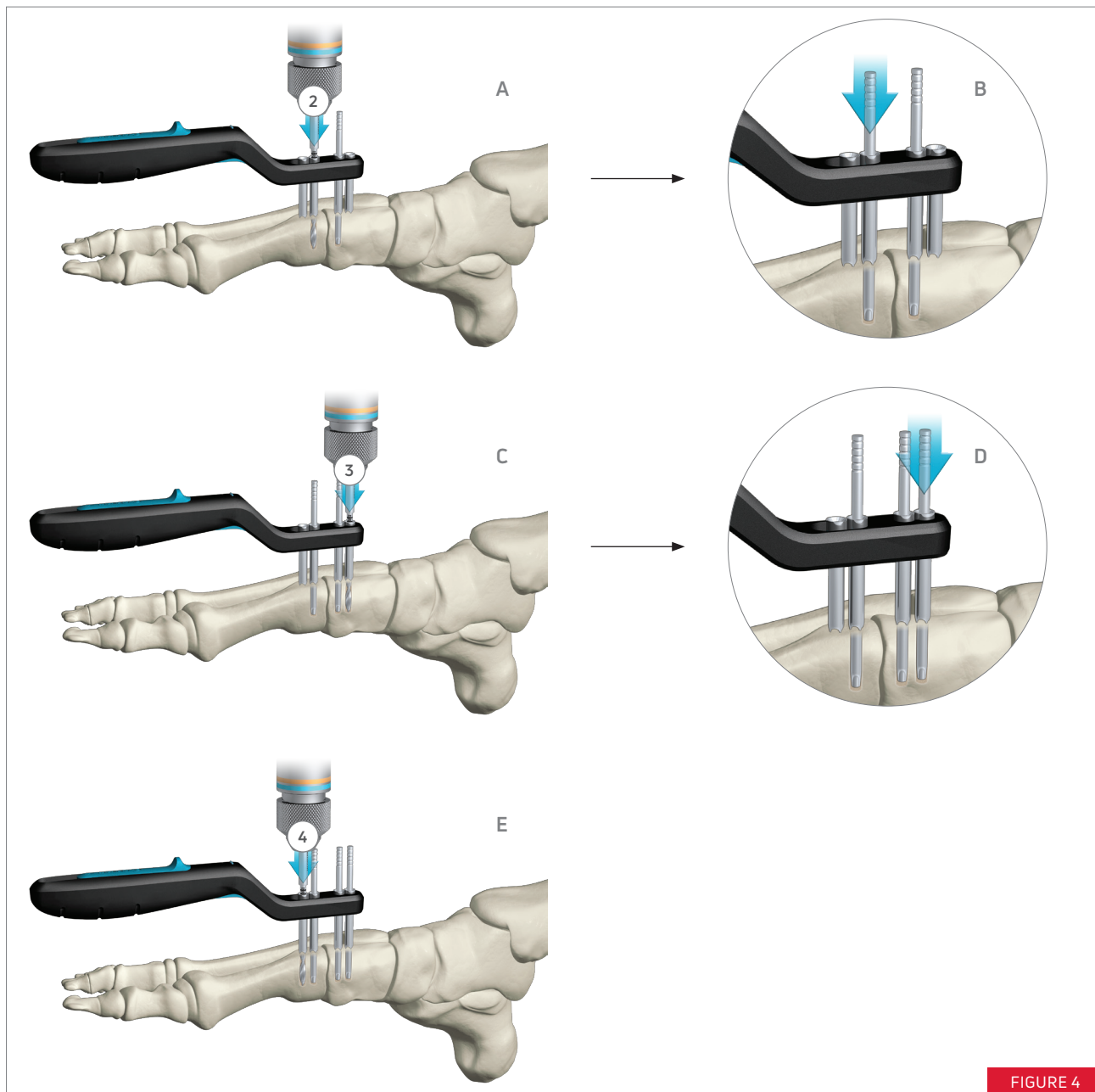

FIGURE 4

5. INSERT THE DYNACLIP FORTE® STAPLE

Select the appropriately sized DynaClip Forte® pre-loaded on the Inserter. Position the legs of the DynaClip Forte over the pilot holes and advance the staple into the bone by hand (**FIGURE 5**).

The staple legs should easily slide into the drilled holes without requiring excessive force. If necessary, lightly mallet on the Strike Surface of the Inserter until the Inserter Tip is flush to the bone.

TIP:

- If implanting in the forefoot, be sure to hold the phalanges and apply counter pressure while inserting the staple.
- It is important to ensure the bottom of the Inserter Tip is fully seated on the bone prior to deployment to avoid having to overly tamp the staple (**A**).

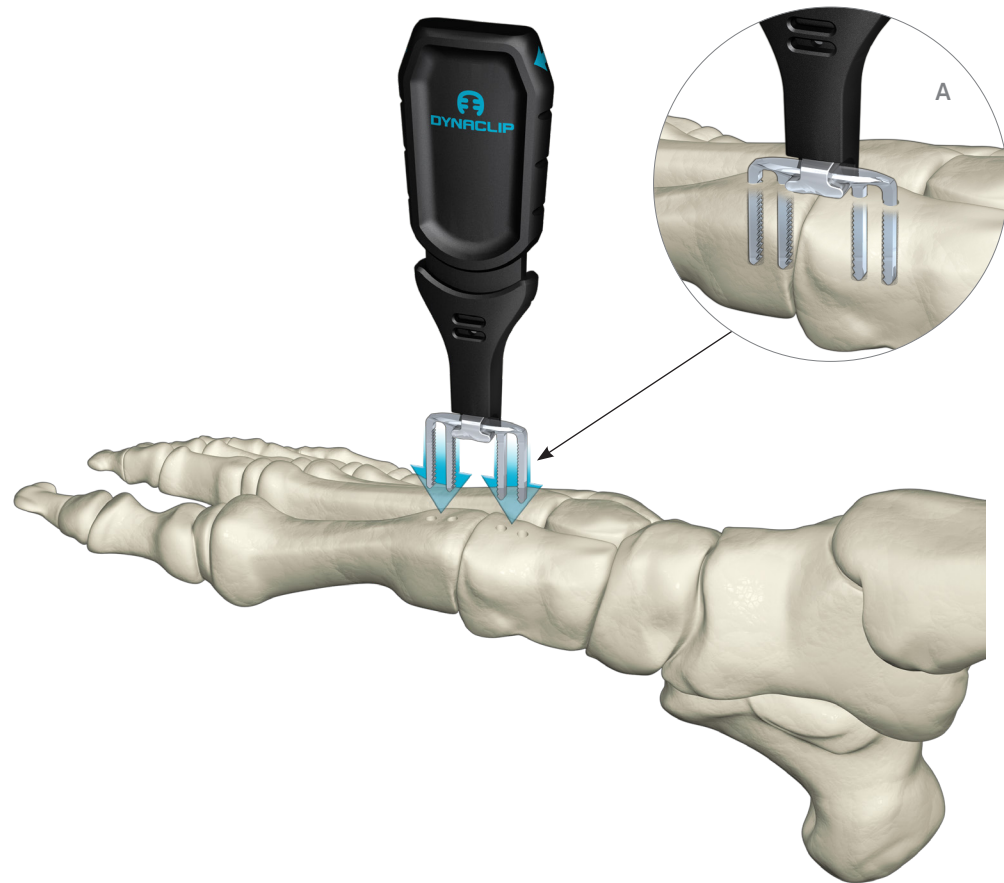

FIGURE 5

6. RELEASE THE DYNACLIP® STAPLE

6A. PULL UP

Grip the Sliding Neck of the Inserter and pull upward to expose the Inserter Tip (**FIGURE 6**).

6B. SLIDE

Slide the Inserter away from the DynaClip Forte® Implant in the direction of the blue DynaClip logo, as indicated by the Blue Arrow on the Inserter (**FIGURE 7**).

TIP:

The Inserter may be twisted slightly to disengage from the implant. Hold the bone in place to keep it stable during removal.

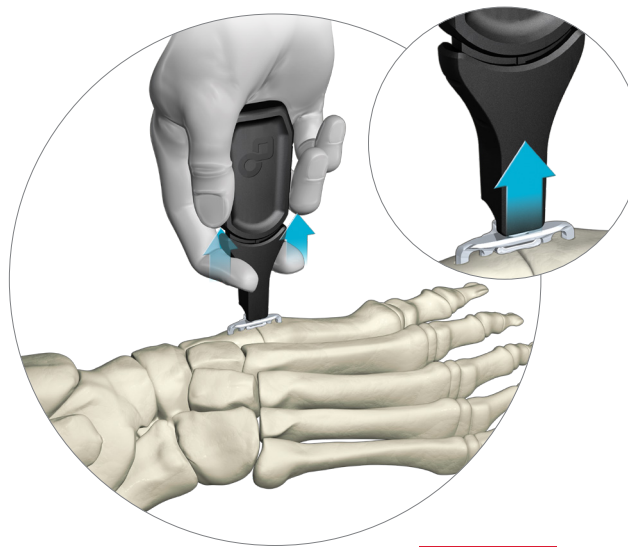

FIGURE 6



FIGURE 7

7. TAMP INTO PLACE

Place the tamping edge of the Inserter Tip over the bridge of the Implant and lightly mallet the Strike Surface to tamp the staple until fully seated on the bone (FIGURE 8).

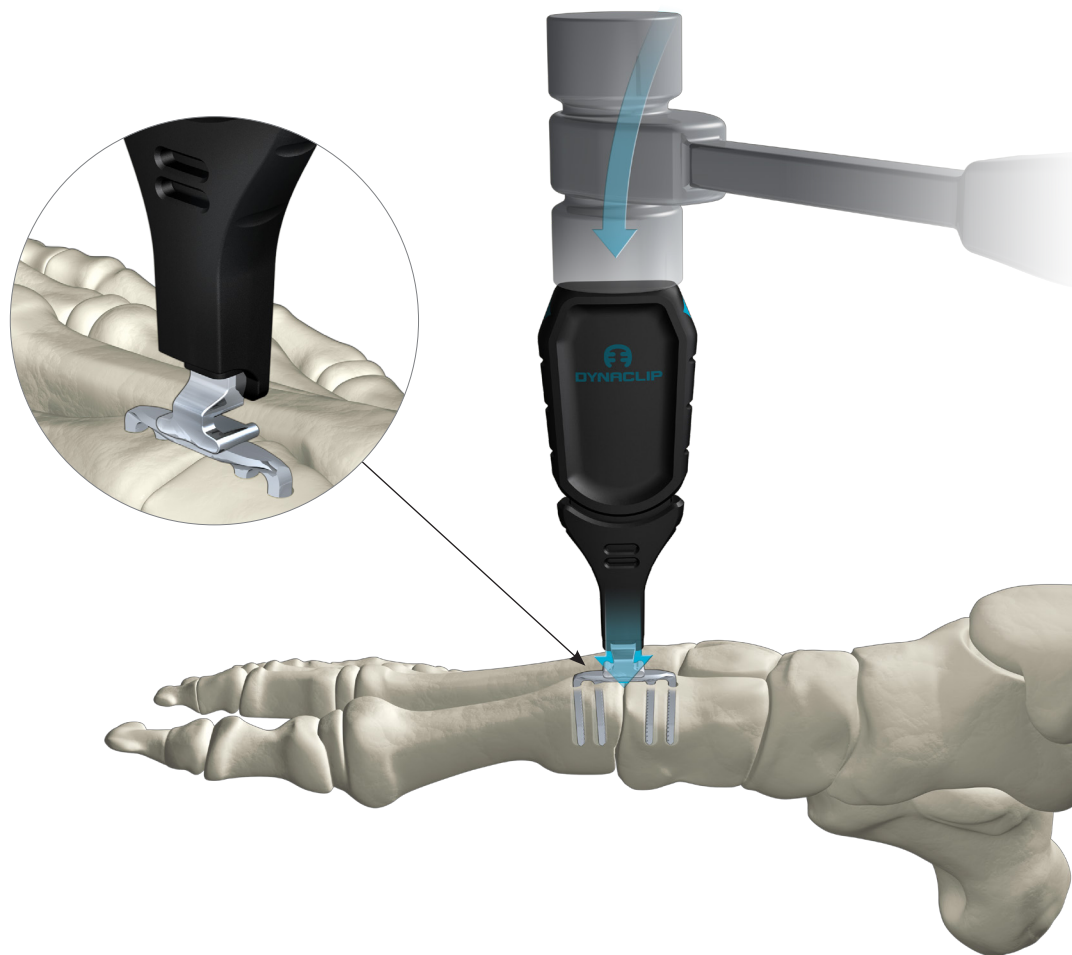
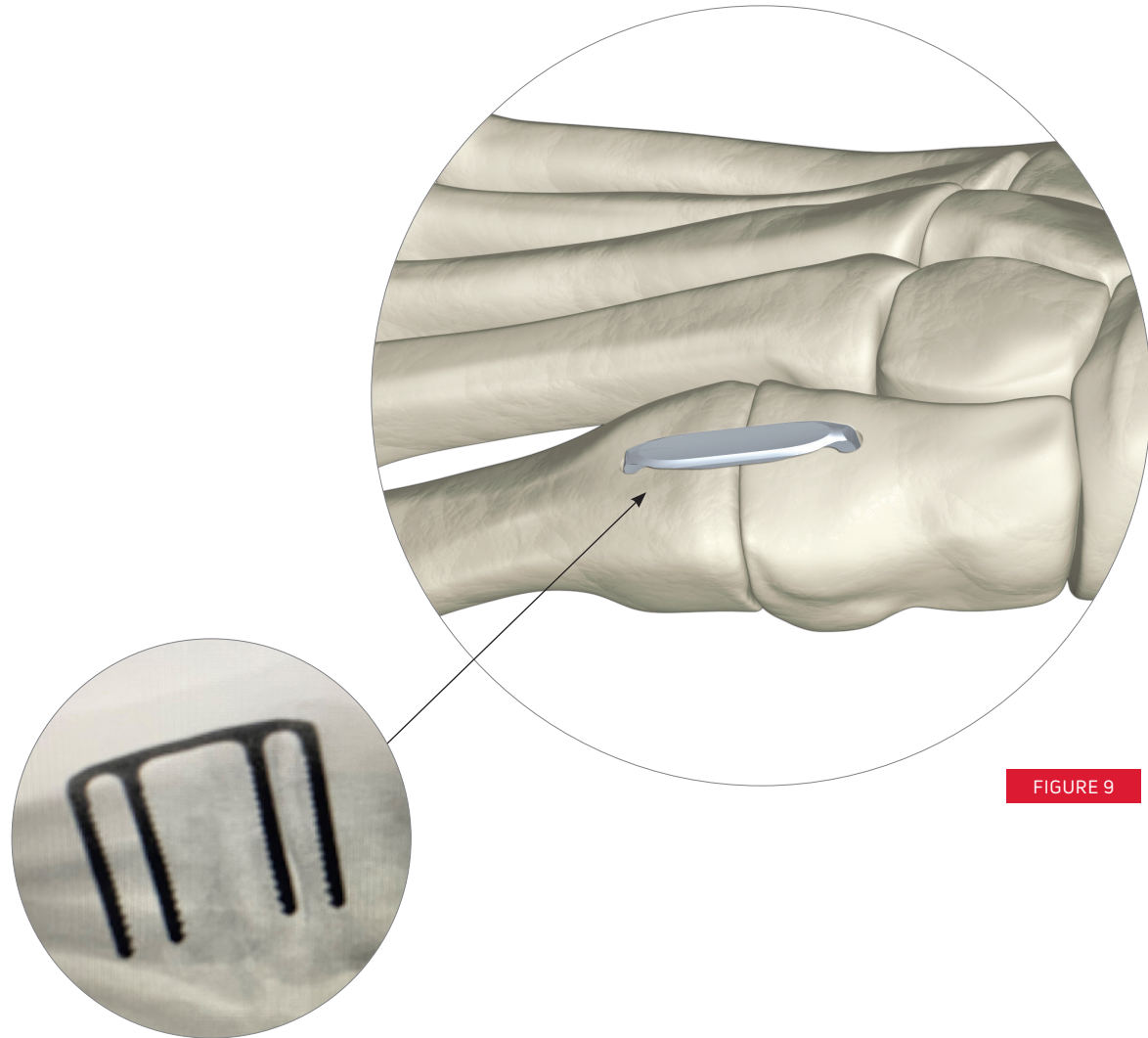

FIGURE 8

8. CONFIRM IMPLANT PLACEMENT

Check final positioning under fluoroscopy (FIGURE 9).



9. OPTIONAL: 2-LEG STAPLE PLACEMENT

If an additional implant is desired, place either a 2-leg DynaClip® or 4-leg DynaClip Forte® following the appropriate DynaClip Surgical Technique Guide. Positioning of the second implant relative to the first implant may be visualized using the Drill Guide under fluoroscopy prior to drilling.

FORTE STAPLE SIZE	RECOMMENDED ORTHOGONAL 2-LEG DYNACLIP STAPLE SIZE (MM)
26 x 16	18 x 18, 20 x 18
26 x 20	18 x 18, 18 x 20, 20 x 18, 20 x 22
30 x 16	26 x 20
30 x 20	26 x 20

If one of the recommended 2-leg DynaClip sizes is desired, the Forte Drill Guide may be used with a 3.0 mm Drill and Pin in the drilling order shown (FIGURE 10).

TIP: If placing two DynaClip Implants 90 degrees to each other, stagger placement to ensure unobstructed insertion (A).

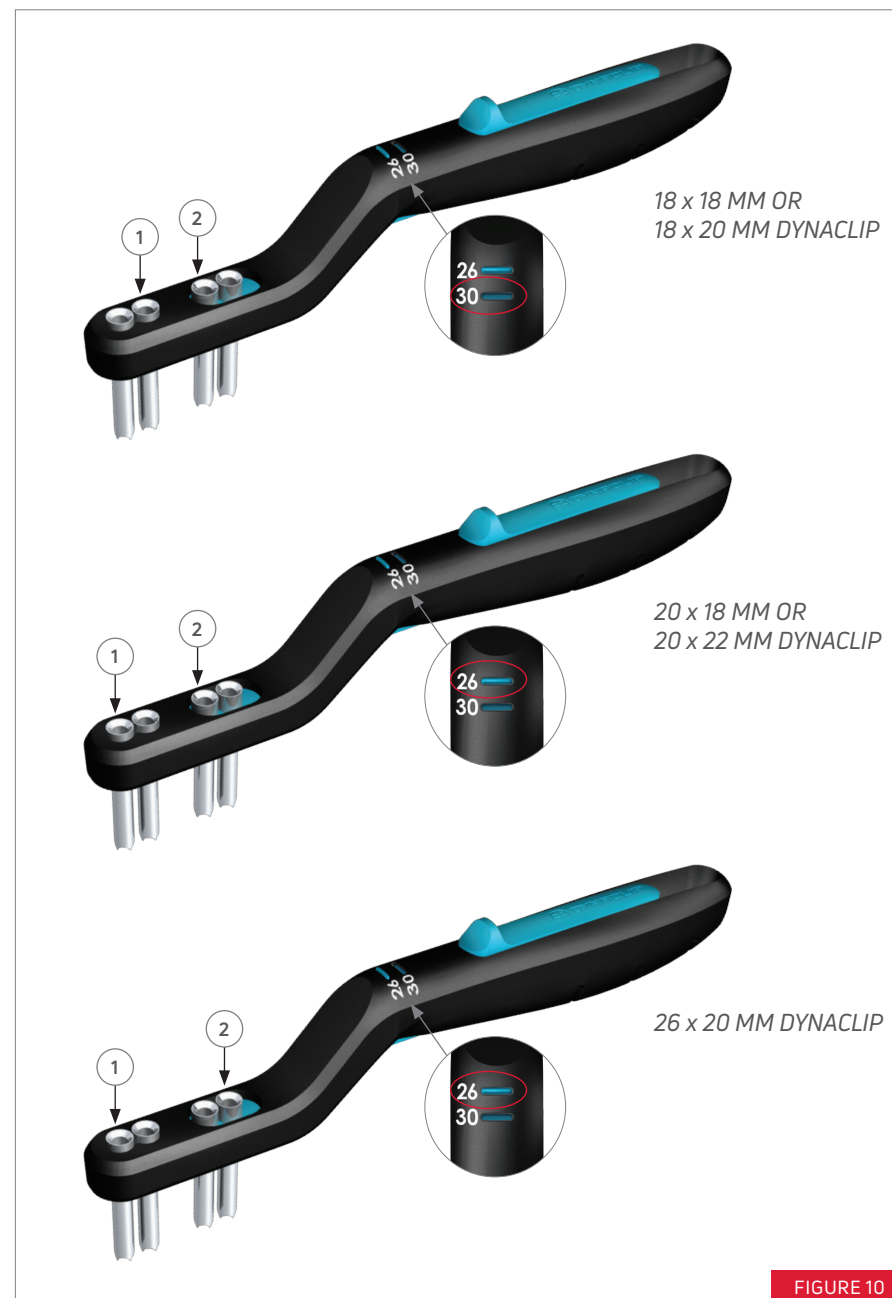
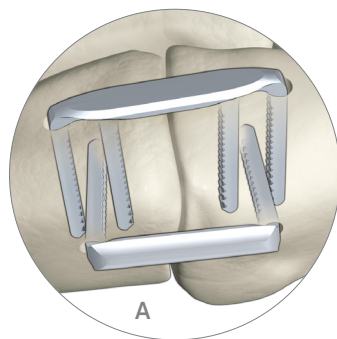
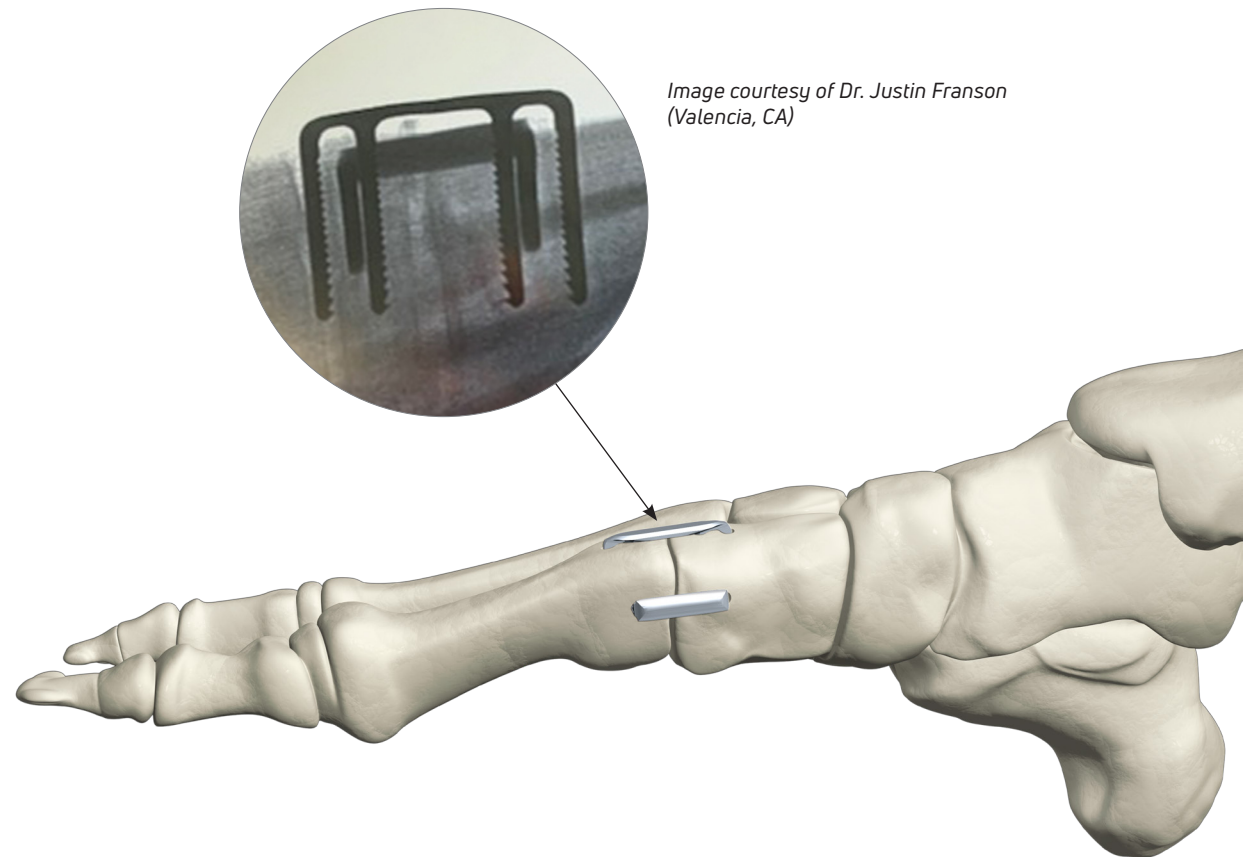

FIGURE 10

8. OPTIONAL: ADDITIONAL 4-LEG (DYNACLIP FORTE®) STAPLE PLACEMENT

Repeat Steps 2-9 for each additional DynaClip Forte® used. Then close wounds and finish procedure (FIGURE 11).



*Image courtesy of Dr. Justin Franson
(Valencia, CA)*

FIGURE 11

The DynaClip Forte® Implant can be removed and re-positioned in bone using the reusable Re-Load Tool.

To remove a DynaClip Forte Implant, use a flat-sided instrument to wedge the bridge of the DynaClip Forte implant slightly off the bone. Place the Re-Load Tool's Posts under the implant bridge and adjust the Ratchet Arms of the Re-Load Tool until the posts are pushing against the staple corners. Pull up on the Re-Load Tool to remove the staple from the bone.

To reposition the DynaClip Forte implant, (if needed) squeeze the arms of the Re-Load Tool to expand the implant legs until parallel, ensuring the legs do not go past parallel. Re-insert the DynaClip Forte implant into the bone and remove the Re-Load Tool by releasing the Ratchet Arms. With the original Inserter, tamp the DynaClip Forte implant until flush with bone.

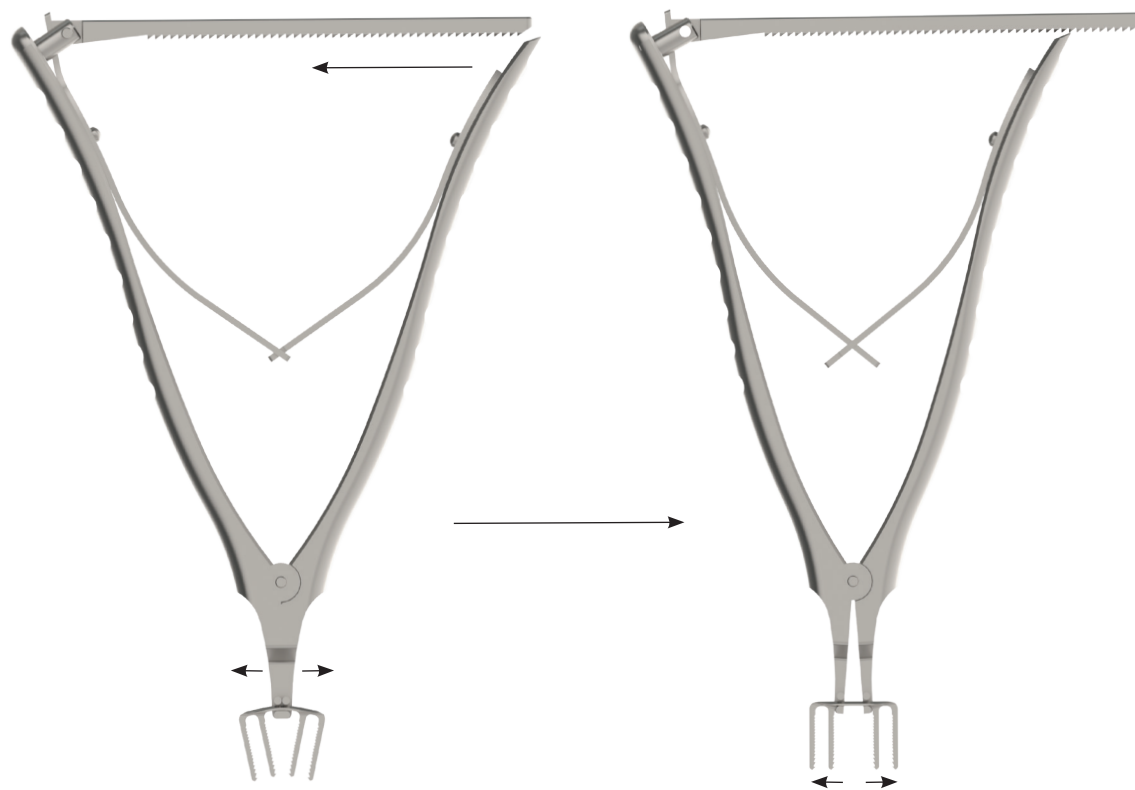

DYNACLIP FORTE® IMPLANTS & SINGLE-USE INSTRUMENTS

DESCRIPTION	PART #
DYNACLIP, 4-LEG INLINE, 26 MM x 16 MM	3000-06-261616
DYNACLIP, 4-LEG INLINE, 26 MM x 20 MM	3000-06-262020
DYNACLIP, 4-LEG INLINE, 30 MM x 16 MM	3000-06-301616
DYNACLIP, 4-LEG INLINE, 30 MM x 20 MM	3000-06-302020
DISPOSABLE PROCEDURE PACK, STERILE	3000-04-000

enovis

T 800.495.2919 F 877.778.3864

Medshape, Inc.
1575 Northside Drive NW | Suite 440 | Atlanta, GA 30318 | U.S.A.
enovis.com/foot-and-ankle

Copyright © 2023 MedShape, Inc.
MK-10204 Rev 01

Individual results may vary. Neither Medshape, Inc. nor any of the Enovis companies dispense medical advice. The contents of this document do not constitute medical, legal, or any other type of professional advice. Rather, please consult your healthcare professional for information on the courses of treatment, if any, which may be appropriate for you.